

## GF Serisi Filtre / GF Series Filter

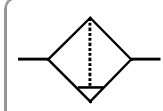

Sembol / Symbol



## Özellikler / Specification

Model / Model	GF200-06	GF200-08	GF300-08	GF300-10	GF300-15	GF400-10	GF400-15	GF600-20	GF600-25
Akışkan / Fluid	Hava / Air								
Bağlantı Ölçüsü / Port Size	1/8"	1/4"	1/4"	3/8"	1/2"	3/8"	1/2"	3/4"	1"
Filtreleme Seviyesi / Filtering Grade	40µ veya / or 5µ								
Basınç Aralığı / Pressure Range	1.5~9.0bar / 0.15~0.9MPa / 12~128Psi								
Max. Çalışma Basıncı / Max. Pressure	10.0bar / 1.0MPa / 142Psi								
Test Basıncı / Proof Pressure	15.0bar / 1.5MPa / 213Psi								
Sıcaklık / Temperature	5~60°C								
Filtre Kavanoz Kapasitesi / Drain Bowl Capacity	10cc		40cc			80cc		230cc	
Ağırlık / Weight	133g		360g			680g		1050g	

## Akış Diyagramı / Flow Chart

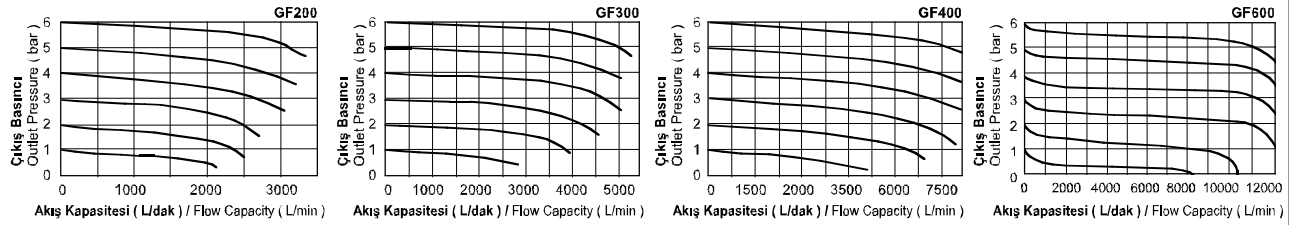

## Teknik Çizimler / Technical Drawing

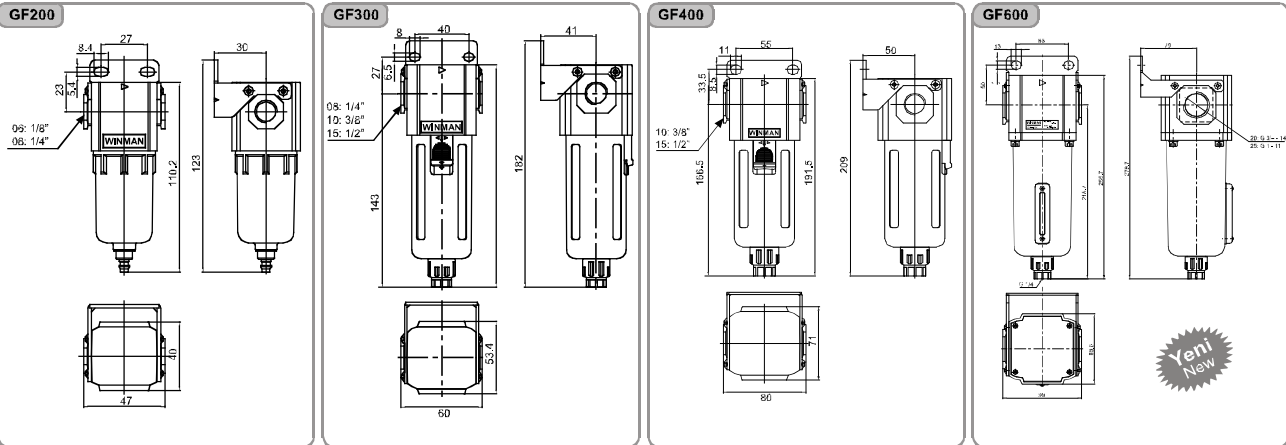

## Sipariş Kodu / Ordering Code

GF200	08	M	-	W	G
Model / Model	Bağlantı / Port	Tahliye / Drain	Aksesuarlar / Accessories	Filtreleme Derecesi / Filtering Grade	Diş Tipi / Thread
GF200	06: 1/8" 08: 1/4"	Boş / Blank: Yarı Otomatik Semi Auto Drain	Boş / Blank: Braketli / Bracket	Boş / Blank: 40µ	Boş / Blank: PT
GF300	08: 1/4" 10: 3/8" 15: 1/2"	M: Elle Tahliye Manuel Drain	J: Braketsiz No Bracket	W: 5µ	G: BSPP T: NPT
GF400	10: 3/8" 15: 1/2"	A: Otomatik Auto Drain			
GF600	20: 3/4" 25: 1"				